

Read this Quick Setup Guide before using the printer.
 Before you can use the printer, you must set up the hardware and install the driver.

Step 1

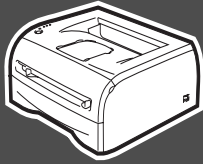

Setting Up Your Printer

Step 2



Installing the Printer Driver

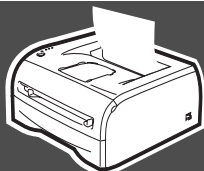
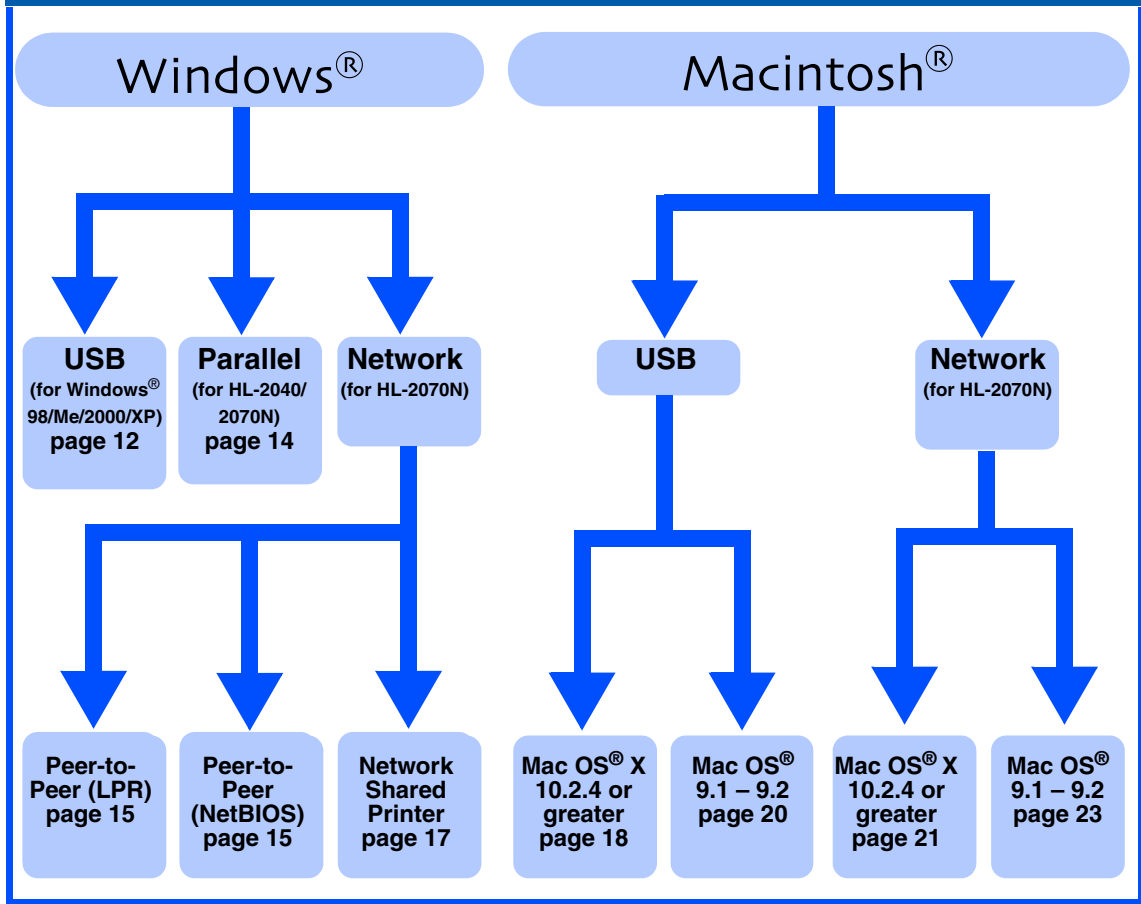

Setup is Complete!



How to use the printer, see the User's Guide in the CD-ROM.

For the latest driver and to find the best solution for your problem or question, access the Brother Solutions Center directly from the CD-ROM/Driver or go to <http://solutions.brother.com>. Keep this Quick Setup Guide and supplied CD-ROM in a convenient place for quick and easy reference at all times.

Setting Up Your Printer

Windows® USB

Windows® Parallel

Windows® Network

Installing the Printer Driver





Macintosh® USB



Macintosh® Network

For Administrators

Safety Precautions

To Use the Printer Safely

| | | | |
|---|---|---|---|
|  <p>Warning</p> |  <p>Electrical Hazard</p> |  <p>Hot Surface</p> |  <p>Caution</p> |
| <p>Warnings tell you what to do to prevent possible personal injury.</p> | <p>Electrical Hazard icons alert you to a possible electrical shock.</p> | <p>Hot Surface icons warn you not to touch machine parts that are hot.</p> | <p>Cautions specify procedures you must follow or avoid to prevent possible damage to the printer.</p> |

| | | |
|--|--|--|
|  <p>Improper Setup</p> |  <p>Note</p> |  <p>User's Guide Network User's Guide</p> |
| <p>Improper Setup icons alert you to devices and operations that are not compatible with the printer.</p> | <p>Notes tell you how you should respond to a situation that may arise or give tips about how the current operation works with other features.</p> | <p>Indicates reference to the User's Guide or Network User's Guide which is on the CD-ROM we have supplied.</p> |

Warning







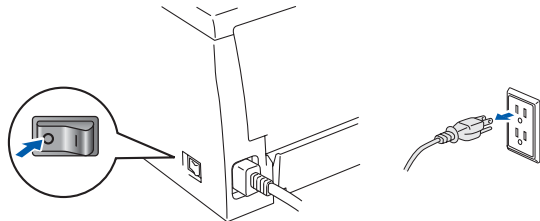

| | |
|---|--|
|  <p>There are high voltage electrodes inside the printer. Before you clean the inside of the printer, make sure you have turned off the power switch and unplugged the printer from the AC power outlet.</p> |  |
|  <p>Do not handle the plug with wet hands. Doing this might cause an electrical shock.</p> |  |
|  <p>After you have just used the printer, some internal parts of the printer are extremely hot. When you open the front or back cover of the printer, never touch the shaded parts shown in the illustration.</p> |  <p>Inside the printer (Front View) Open the back cover (Back View)</p> |
|  <p>The fuser unit is marked with the caution labels. Please do not remove or damage the labels.</p> |  |
|  <p>Do not use a vacuum cleaner to clean up scattered toner. Doing this might cause the toner dust to ignite inside the vacuum cleaner, potentially starting a fire. Please carefully clean the toner dust with a dry, lint-free cloth and dispose of it according to local regulations.</p> | |

Table of Contents

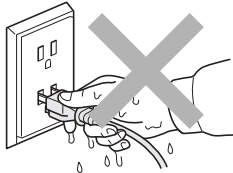
| | |
|---------------------------------|---|
| To Use the Printer Safely | 2 |
| Regulations | 2 |

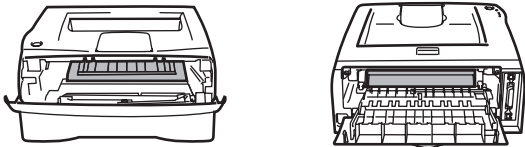
■ Getting Started

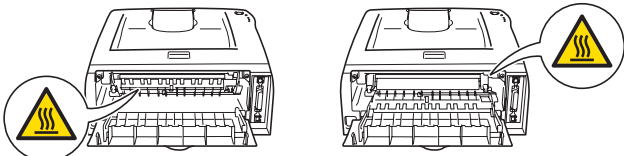
| | |
|-------------------------|---|
| Carton Components | 4 |
| Control Panel | 5 |
| Supplied CD-ROM | 6 |

Step 1 Setting Up Your Printer

| | |
|---|----|
| ■ Insert the CD-ROM into the CD-ROM Drive | 7 |
| ■ Install the Drum Unit Assembly | 8 |
| ■ Load Paper in the Paper Tray | 9 |
| ■ Print a Test Page | 10 |

Step 2 Installing the Printer Driver

| | | |
|--|--|----|
| Windows® | For USB Interface Cable Users (Windows® 98/Me/2000/XP Users) | 12 |
| | For Parallel Interface Cable Users (HL-2040/2070N Users) | 14 |
| | For Network Interface Cable Users (HL-2070N Users) | 15 |
| | ■ For Brother Peer-to-Peer Network Printer Users (LPR / NetBIOS) | 15 |
| ■ For Network Shared Printer Users | 17 | |
| Macintosh® | For USB Interface Cable Users | 18 |
| | ■ For Mac OS® X 10.2.4 or greater Users | 18 |
| | ■ For Mac OS® 9.1 to 9.2 Users | 20 |
| | For Network Interface Cable Users (HL-2070N Users) | 21 |
| | ■ For Mac OS® X 10.2.4 or greater Users | 21 |
| ■ For Mac OS® 9.1 to 9.2 Users | 23 | |

■ For Administrators (HL-2070N Users)

| | |
|--|----|
| Installing the BRAdmin Professional Configuration Utility (Windows® Users Only) | 24 |
| Setting your IP Address, Subnet Mask and Gateway using BRAdmin Professional (Windows® Users Only) | 24 |
| Web browser | 25 |
| Network Factory Default Setting | 25 |
| Print the Printer Settings Page | 25 |

■ Other Information

| | |
|-------------------------------|----|
| Shipment of the Printer | 26 |
| Option | 27 |
| Consumables | 27 |

■ Troubleshooting

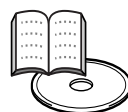

Regulations

Federal Communications Commission (FCC) Declaration of Conformity (For USA)

Responsible Party: Brother International Corporation
100 Somerset Corporate Boulevard
P.O. Box 6911
Bridgewater, NJ 08807-0911
USA
Telephone: (908) 704-1700

declares, that the products

Product name: Laser Printer
Model number: Laser Printer HL-2030, HL-2040 and HL-2070N
Model number: HL-20
Product options: ALL

complies with Part 15 of the FCC Rules. Operation is subject to the following two conditions: (1) This device may not cause harmful interference, and (2) this device must accept any interference received, including interference that may cause undesired operation.

This equipment has been tested and found to comply with the limits for a Class B digital device, pursuant to Part 15 of the FCC Rules. These limits are designed to provide reasonable protection against harmful interference in a residential installation. This equipment generates, uses, and can radiate radio frequency energy and, if not installed and used in accordance with the instructions, may cause harmful interference to radio communications. However, there is no guarantee that interference will not occur in a particular installation. If this equipment does cause harmful interference to radio or television reception, which can be determined by turning the equipment off and on, the user is encouraged to try to correct the interference by one or more of the following measures:

- Reorient or relocate the receiving antenna.
- Increase the separation between the equipment and receiver.
- Connect the equipment into an outlet on a circuit different from that to which the receiver is connected.
- Consult the dealer or an experienced radio/TV technician for help.

Important

A shielded interface cable should be used in order to ensure compliance with the limits for a Class B digital device. Changes or modifications not expressly approved by Brother Industries, Ltd. could void the user's authority to operate the equipment.

Industry Canada Compliance Statement (For Canada)

This Class B digital apparatus complies with Canadian ICES-003.

Cet appareil numérique de la classe B est conforme à la norme NMB-003 du Canada.

Radio interference (220-240 volt model only)

This printer follows EN55022 (CISPR Publication 22)/Class B. Before you use this product, make sure that you use the following interface cables.

1. A shielded parallel interface cable with twisted-pair conductors and that it is marked "IEEE 1284 compliant".
2. A USB cable.

The cable must not be more than 2 meters long.

EC Declaration of Conformity

Manufacturer
Brother Industries Ltd.,
15-1, Naeshiro-cho, Mizuho-ku,
Nagoya 467-8561, Japan

Plant
Brother Corporation (Asia) Ltd.,
Brother Buji Nan Ling Factory,
Gold Garden Ind., Nan Ling Village,
Buji, Rong Gang, Shenzhen, China

Herewith declare that:

Products description : Laser Printer
Product Name : HL-2030, HL-2040, HL-2070N
Model Number : HL-20

are in conformity with provisions of the Directives applied : Low Voltage Directive 73/23/EEC (as amended by 93/68/EEC) and the Electromagnetic Compatibility Directive 89/336/EEC (as amended by 91/263/EEC and 92/31/EEC and 93/68/EEC).

Harmonized standards applied :

Safety : EN60950:2000

EMC : EN55022:1998 Class B
EN55024:1998 + A1:2001
EN61000-3-2:2000
EN61000-3-3:1995 + A1:2001

Year in which CE marking was first affixed : 2004

Issued by : Brother Industries, Ltd.

Date : 29th June, 2004

Place : Nagoya, Japan

Signature :

Takashi Maeda
Manager
Quality Management Group
Quality Management Dept.
Information & Document Company

International ENERGY STAR® Compliance Statement

The purpose of the International ENERGY STAR® Program is to promote the development and popularization of energy-efficient office equipments. As an ENERGY STAR® Partner, Brother Industries, Ltd. has determined that this product meets the ENERGY STAR® guidelines for energy efficiency.



Laser Safety (100 to 120 volt Model Only)

This printer is certified as a Class 1 laser product under the U.S. Department of Health and Human Services (DHHS) Radiation Performance Standard according to the Radiation Control for Health and Safety Act of 1968. This means that the printer does not produce hazardous laser radiation.

Since radiation emitted inside the printer is completely confined within protective housings and external covers, the laser beam cannot escape from the machine during any phase of user operation.

FDA Regulations (100 to 120 volt Model Only)

U.S. Food and Drug Administration (FDA) has implemented regulations for laser products manufactured on and after August 2, 1976. Compliance is mandatory for products marketed in the United States. One of the following labels on the back of the printer indicates compliance with the FDA regulations and must be attached to laser products marketed in the United States.

MANUFACTURED:
Brother Industries, Ltd.,
15-1 Naeshiro-cho Mizuho-ku Nagoya, 467-8561 Japan
This product complies with FDA performance standards for laser products except for deviations pursuant to Laser Notice No.50, dated July 26, 2001.

MANUFACTURED:
Brother Corporation (Asia) Ltd. Brother Buji Nan Ling Factory
Gold Garden Ind., Nan Ling Village, Buji, Rong Gang, Shenzhen, CHINA
This product complies with FDA performance standards for laser products except for deviations pursuant to Laser Notice No.50, dated July 26, 2001.

- Caution: Use of controls, adjustments or performance of procedures other than those specified in this manual may result in hazardous radiation exposure.

IEC 60825-1 specification (220 to 240 volt model only)

This printer is a Class 1 laser product as defined in IEC 60825-1 specifications. The label shown below is attached in countries where it is needed.

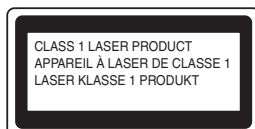

This printer has a Class 3B laser diode which produces invisible laser radiation in the scanner unit. You should not open the scanner unit under any circumstances.

- Caution: Use of controls or adjustments or performance of procedures other than those specified herein may result in hazardous radiation exposure.

For Finland and Sweden

LUOKAN 1 LASERLAITE

KLASS 1 LASER APPARAT

- Varoitus! Laitteen käyttäminen muulla kuin tässä käyttöohjeessa mainitulla tavalla saattaa altistaa käyttäjän turvallisuusluokan 1 ylittävälle näkymättömälle lasersäteilylle.
- Varning Om apparaten används på annat sätt än i denna Bruksanvisning specificerats, kan användaren utsättas för osynlig laserstrålning, som överskrider gränsen för laserklass 1.

Internal laser radiation

Maximum radiation power: 5 mW
Wave length: 770 - 810 nm
Laser class: Class 3B

IMPORTANT - For Your Safety

To ensure safe operation the supplied three-pin plug must be inserted only into a standard three-pin power outlet that is properly grounded through the normal household wiring.

Extension cords used with this printer must be three-pin plug type and correctly wired to provide proper grounding. Incorrectly wired extension cords may cause personal injury and equipment damage.

The fact that the equipment operates satisfactorily does not imply that the power is grounded and that the installation is completely safe. For your safety, if in any doubt about the effective grounding of the power, call a qualified electrician.

Disconnect device

You must install this printer near a power outlet that is easily accessible. In case of an emergency, you must disconnect the power cord from the power outlet to shut off the power completely.

Caution for LAN connection (For model HL-2070N only)

Connect this product to a LAN connection that is not subjected to over voltages.

IT power system (For Norway only)

This product is also designed for an IT power system with phase-to-phase voltage 230V.

Wiring information (for UK)

Important

If you need to replace the plug fuse, fit a fuse that is approved by ASTA to BS1362 with the same rating as the original fuse.

Always replace the fuse cover. Never use a plug that does not have a cover.

Warning - This printer must be earthed.

The wires in the mains lead are coloured in line with the following code:

Green and Yellow: Earth
Blue: Neutral
Brown: Live

If in any doubt, call a qualified electrician.

Carton Components

Printer

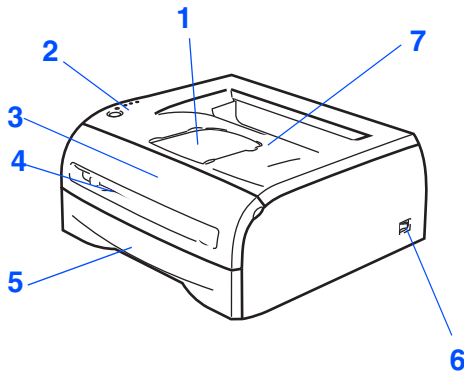

- 1 Face-down Output Tray Support Flap (Support Flap)
- 2 Control Panel
- 3 Front Cover
- 4 Manual Feed Slot
- 5 Paper Tray
- 6 Power Switch
- 7 Face-down Output Tray (Top Output Tray)



CD-ROM
(including User's Guide)

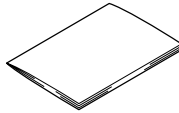

Quick Setup Guide

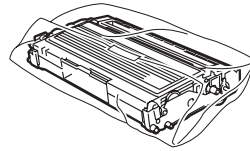

Drum Unit Assembly
(including toner cartridge)

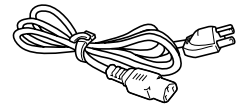

AC Power Cord

Carton components may differ from one country to another.

Save all packing materials and the printer carton in case for any reason you must ship your printer.



The interface cable is not a standard accessory. Please purchase the appropriate interface cable for the interface you intend to use (USB, Parallel or Network).

■ **USB cable**

Do not use a USB interface cable that is longer than 6 feet (2.0 meters).

Do not connect the USB cable to a non-powered hub or a Mac[®] keyboard.

When you use a USB cable, make sure you connect it to the USB connector of your PC.

USB is not supported under Windows[®] 95 or Windows NT[®]4.0.

■ **Parallel interface (For HL-2040 and HL-2070N)**

Do not use a Parallel interface cable that is longer than 6 feet (2.0 meters).

Use a shielded interface cable that is IEEE 1284-compliant.

■ **Network cable (For HL-2070N)**

Use a straight-through Category5 (or greater) twisted-pair cable for 10BASE-T or 100BASE-TX Fast Ethernet Network.

Control Panel



- 1 **Toner** - LED indicates when the Toner is low or empty.
- 2 **Drum** - LED indicates when the Drum is nearing end of life.
- 3 **Paper** - LED indicates when there is Cover open or a paper jam.
- 4 **Ready** - LED indicates when the printer is ready or if Data is remaining.
- 5 **Go Button** - Wake-up / Error recovery / Form feed / Cancel printing / Reprint



User's Guide Chapter 3.

Printer LED Indications

★: Blinking ●: ON ○: OFF

| Printer LED | Sleep / OFF | Warming Up | Ready | Receiving Data | Data Remaining |
|-------------|-------------|------------|------------|----------------|----------------|
| Toner | ○ | ○ | ○ | ○ | ○ |
| Drum | ○ | ○ | ○ | ○ | ○ |
| Paper | ○ | ○ | ○ | ○ | ○ |
| Ready | ○ | ★ Green | ● Green | ★ Green | ★ Green |

| Printer LED | Toner Low | Toner Life End | Drum Life End Soon | Cover Open / Paper Jam | No Paper Fed Tray | Service call |
|---|--------------|----------------|--------------------|------------------------|-------------------|--------------|
| Toner | ★ Yellow* | ● Yellow | ○ | ○ | ○ | ★ Yellow |
| Drum | ○ | ○ | ★ Yellow* | ○ | ○ | ★ Yellow |
| Paper | ○ | ○ | ○ | ★ Red | ● Red | ★ Red |
| Ready | ● Green | ○ | ● Green | ○ | ○ | ★ Green |
|  User's Guide | Chapter 5 | Chapter 5 | Chapter 5 | Chapter 6 | Chapter 1 | Chapter 3 |

* The LED will blink in a pattern of ON for 2 seconds and then OFF for 3 seconds.

Supplied CD-ROM

You can find a variety of information on the CD-ROM.

Windows®

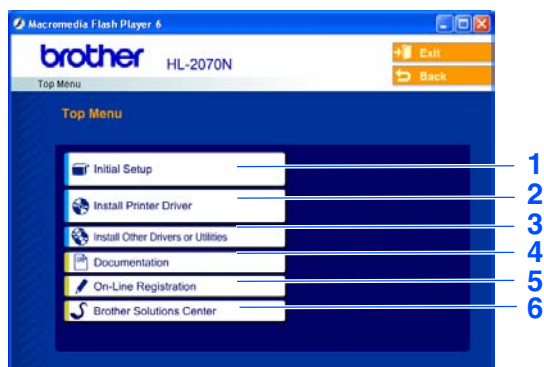

Macintosh®

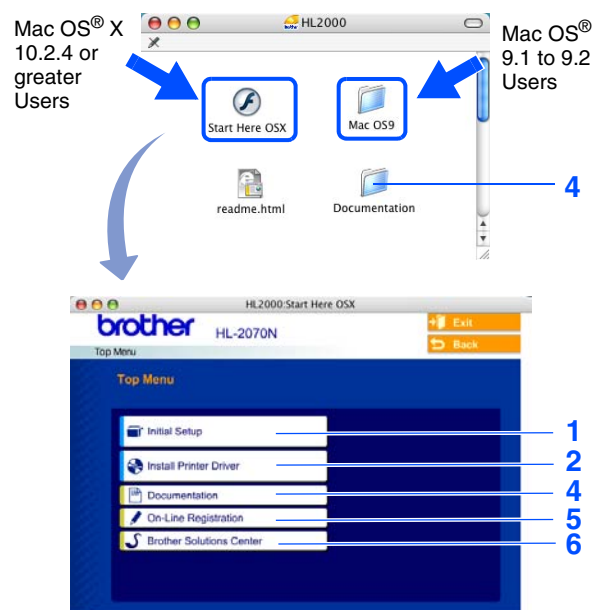

This screen is not supported by Mac OS® 9.1 to 9.2.

1 Initial Setup

Instructional movie for printer setup.

2 Install Printer Driver

Install the printer driver.

3 Install Other Drivers or Utilities

Install optional drivers, utilities and Network management tools.

4 Documentation

View the Printer User's Guide and Network User's Guide in PDF format. (Viewer included)

You can also view the User's Guide in HTML format by accessing the Brother Solutions Center.

■ *The User's Guide in PDF format will be installed automatically when you install the driver. (For Windows® users only) From the Start button, select Programs, your printer (e.g. Brother HL-2070N), and User's Guide. If you do not want to install the User's Guide, select Custom setup from Install Printer Driver, and de-select User's Guide in PDF format when you install the driver.*

5 On-Line Registration

Register your product on-line.

6 Brother Solutions Center

The Brother Solutions Center (<http://solutions.brother.com>) is a one-stop resource for all your printer needs.

Download the latest drivers and utilities for your printers, read the FAQs and troubleshooting tips to learn how to get the most from your Brother product.



For visually impaired users, we have prepared the HTML file on the supplied CD-ROM: readme.html. This file can be read by Screen Reader 'text-to-speech' software.



1 Insert the CD-ROM into the CD-ROM Drive

For Windows® Users

Do NOT connect the interface cable. You will be prompted to connect the interface cable during the driver installation.

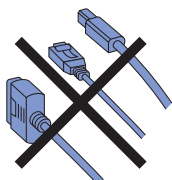

- 1 Insert the CD-ROM into your CD-ROM drive. The opening screen will appear automatically. Select your printer model and the language.



- 2 Click the **Initial Setup** icon on the menu screen.



- 3 You can view the initial setup instructions and follow the steps on pages 8 to 10.

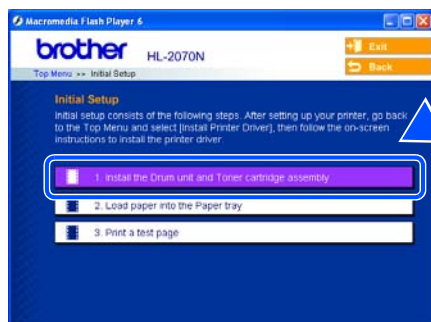

For Macintosh® Users

Do NOT connect the interface cable. You will be prompted to connect the interface cable during the driver installation.

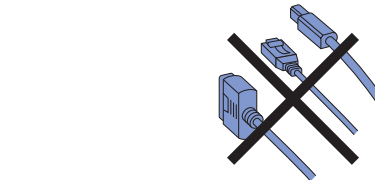

- 1 **For Mac OS® 9.1 to 9.2 Users:**
Go to page 8.
For Mac OS® 10.2.4 or greater Users:
Insert the CD-ROM into your CD-ROM drive, and then double-click the **HL2000** icon on your Desktop. Double-click the **Start Here OS X** icon. Follow the on-screen instructions.

Mac OS® X
10.2.4 or
greater Users

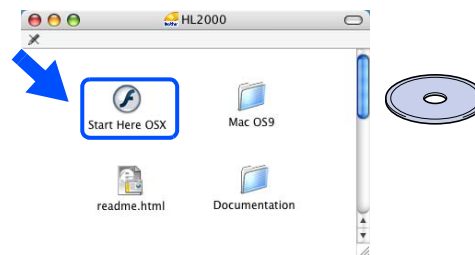

- 2 Click the **Initial Setup** icon on the menu screen.



- 3 You can view the initial setup instructions and follow the steps on pages 8 to 10.

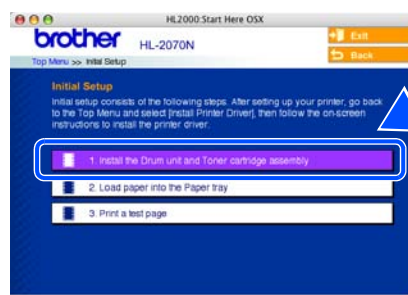

2 Install the Drum Unit Assembly



Do NOT connect the interface cable. You will be prompted to connect the interface cable during the driver installation.

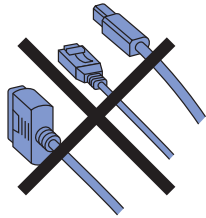

- 1 Open the front cover of the printer.

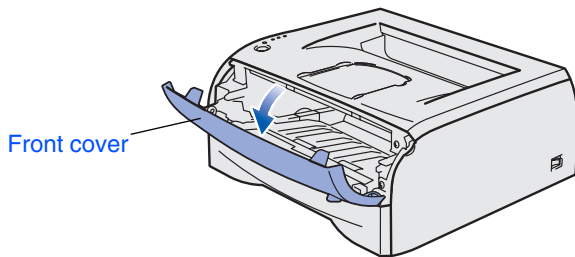

- 2 Unpack the drum unit assembly.

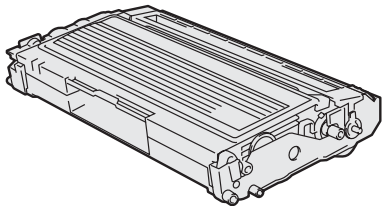

- 3 Rock it from side to side several times to distribute the toner evenly inside the assembly.

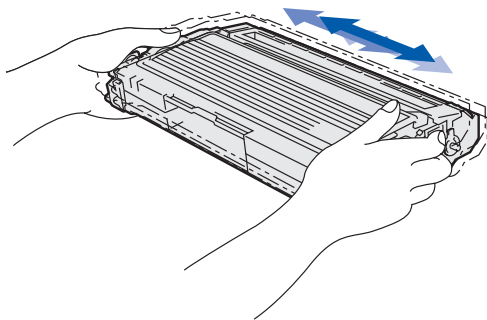

- 4 Put the drum unit assembly into the printer.

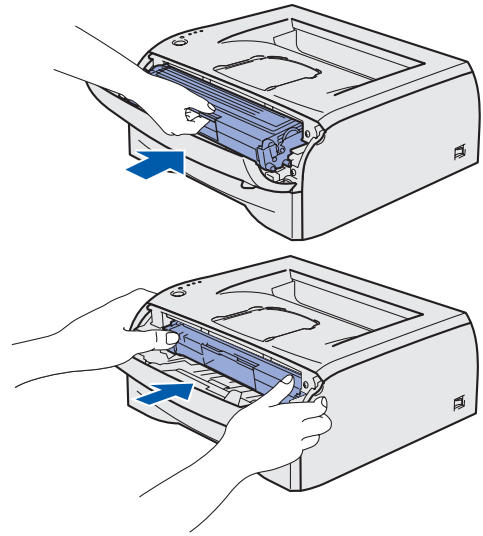

- 5 Close the front cover of the printer.

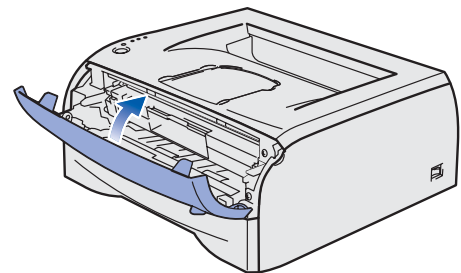

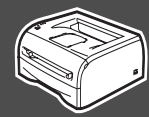

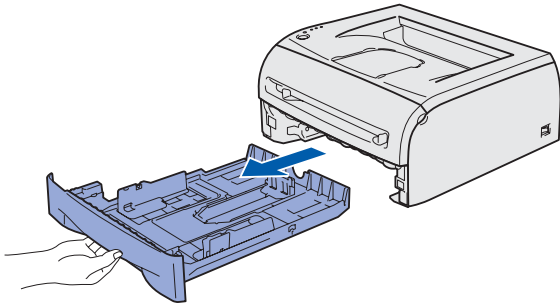

3 Load Paper in the Paper Tray

- 1 Pull the paper tray completely out of the printer.

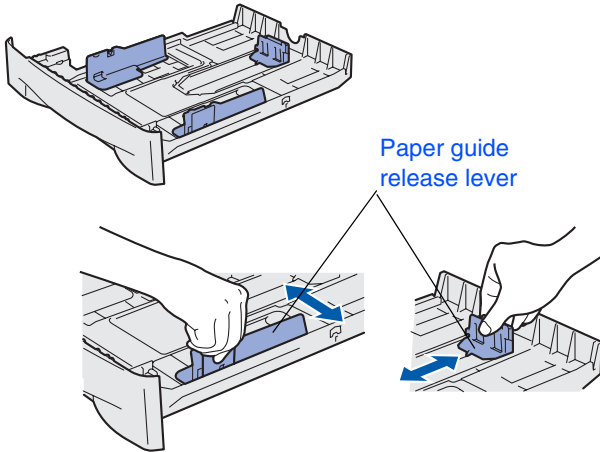

- 2 While pressing the paper guide release lever, slide the adjusters to fit the paper size. Check that the guides are firmly in the slots.



 For Legal size paper, press in the inside latches and pull out the back of the paper tray. (Legal size paper is not available in some regions.)

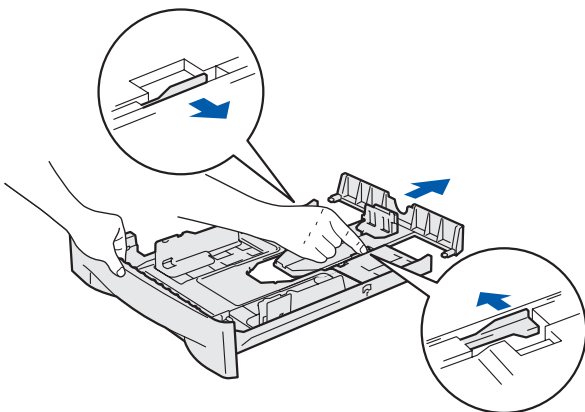

- 3 Fan the stack of paper well to avoid paper jams and misfeeds.

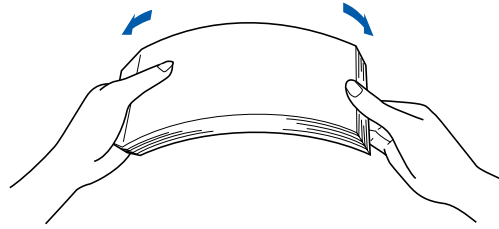

- 4 Put paper in the paper tray. Check that the paper is flat in the tray and below the maximum paper mark.

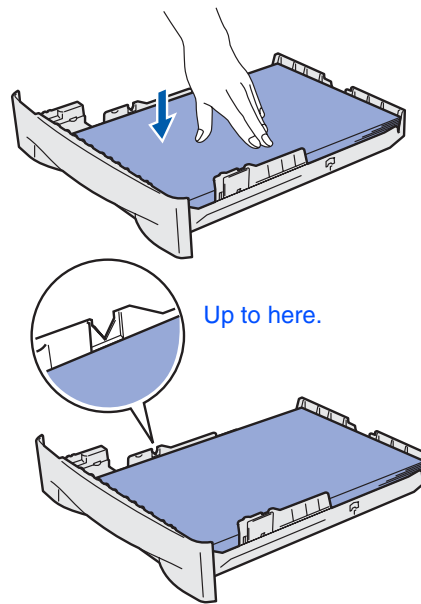

- 5 Put the paper tray firmly back in the printer.

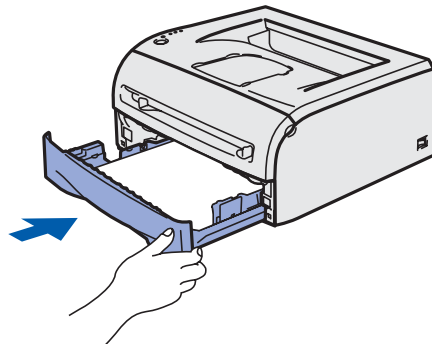

Go to the next page 

Setting Up
Your Printer

Windows®
USB

Windows®
Parallel

Windows®
Network

Macintosh®
USB

Macintosh®
Network

For
Administrators

Installing the Printer Driver

4 Print a Test Page



Do NOT connect the interface cable. You will be prompted to connect the interface cable during the driver installation.

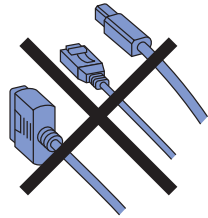

- 1 Make sure that the printer power switch is off.
Connect the AC power cord to the printer.

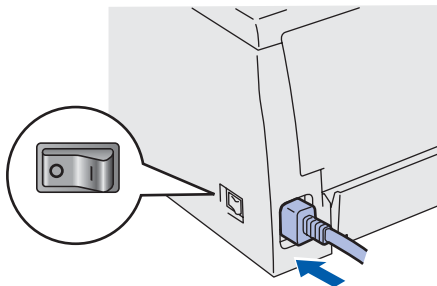

- 2 Plug the AC power cord into an AC outlet.
Turn the power switch on.

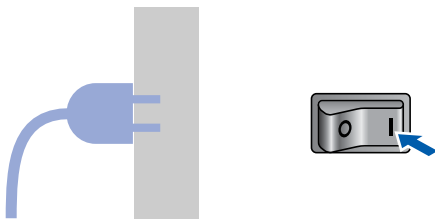

- 3 After the printer has finished warming up, the **Ready** LED stops blinking and stays green.

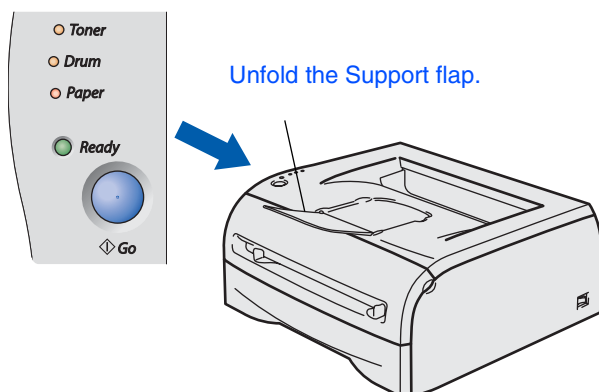

- 4 Press the **Go** button. The printer prints a test page.
Check that the test page has printed correctly.

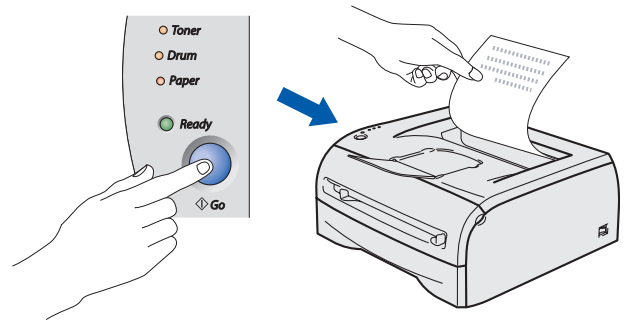

This function won't be available after the first print job you send from your PC.

Go to the next page to install the driver.



Follow the instructions on this page for your operating system and interface cable. The screens for Windows® in this Quick Setup Guide are based on Windows® XP. The screens for Mac OS® X in this Quick Setup Guide are based on Mac OS® X 10.3.

Windows®



For USB Interface Cable Users Go to page 12



For Parallel Interface Cable Users Go to page 14



For Network Interface Cable Users

- **Brother Peer-to-Peer Network Printer Users (LPR) Go to page 15**
- **Brother Peer-to-Peer Network Printer Users (NetBIOS) Go to page 15**
- **Network Shared Printer Users..... Go to page 17**

Macintosh®



For USB Interface Cable Users

- **Mac OS® X 10.2.4 or greater Users Go to page 18**
- **Mac OS® 9.1 to 9.2 Users Go to page 20**



For Network Interface Users

- **Mac OS® X 10.2.4 or greater Users Go to page 21**
- **Mac OS® 9.1 to 9.2 Users Go to page 23**

For Administrators Go to page 24

Windows® USB

Windows® Parallel

Windows® Network

Macintosh® USB

Macintosh® Network

For Administrators



For USB Interface Cable Users (Windows® 98/Me/2000/XP Users)

Installing the driver and connecting the printer to your PC



If the **Found New Hardware Wizard** appears on your PC, click the **Cancel** button.

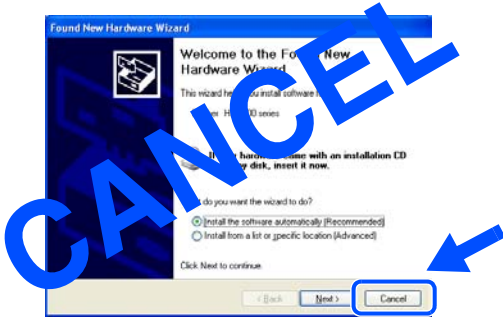

- 1 Make sure the USB interface cable is **NOT** connected to the printer, and then begin installing the driver. If you have already connected the cable, remove it.

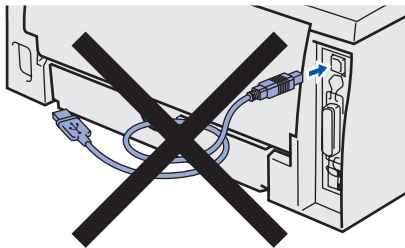

- 2 Click **Install Printer Driver** on the Menu screen.

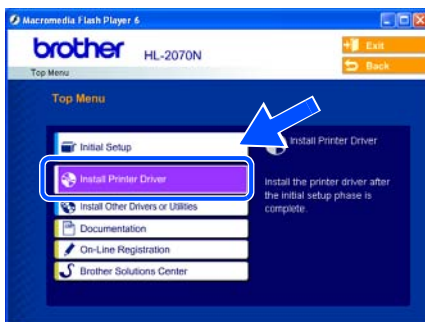

- 3 Select the **USB cable**.



- 4 Read the license agreement carefully. Then follow the on-screen instructions.

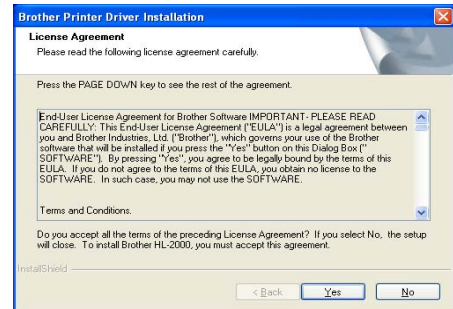

- 5 When this screen appears, make sure the printer power switch is on. Connect the USB interface cable to your PC, and then connect it to the printer. Click the **Next** button.

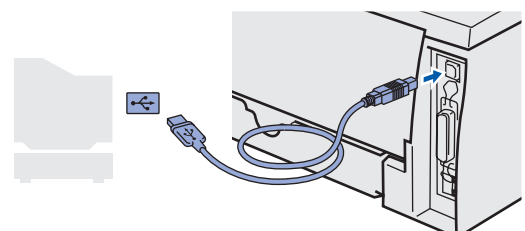
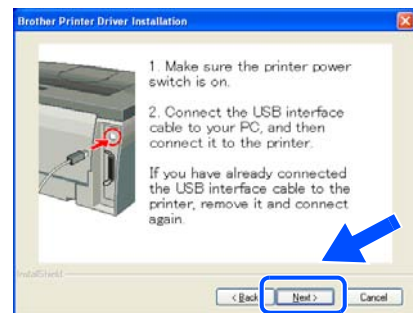

- 6 Click the **Finish** button.

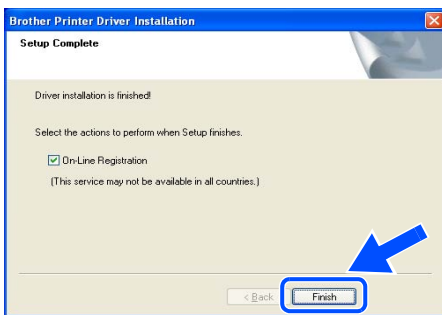

If you want to register your product on-line, check the **On-Line Registration** box.

- OK!** For Windows® 98/Me users:
The Setup is now complete.

- >>** For Windows® 2000/XP users:
Go to "Setting Your Printer as the Default Printer" on the next page.

Setting your printer as the default printer (For Windows® 2000/XP users only)

- 1 Click **Start** and then **Printers and Faxes**.



- 2 Select the icon of the appropriate printer.

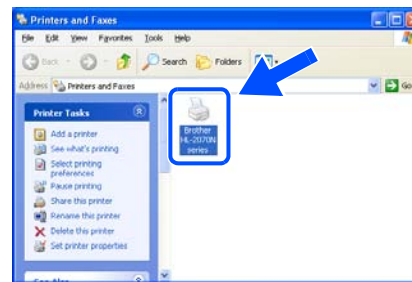

- 3 From the **File** menu, select **Set as Default printer**.

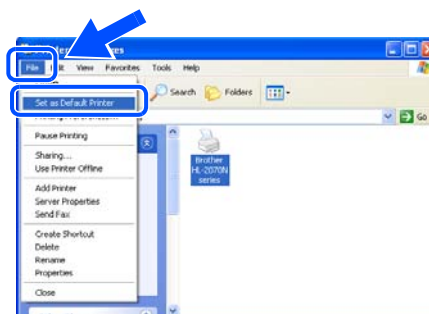

- OK!** The setup is now complete.



For Parallel Interface Cable Users (HL-2040/2070N Users)

Connecting the printer to your PC and installing the driver

- 1 Click **Install Printer Driver** on the Menu screen.



- 2 Select the **Parallel** interface.



- 3 Turn off the printer power switch.



- 4 Connect the parallel interface cable to your PC, and then connect it to your printer.

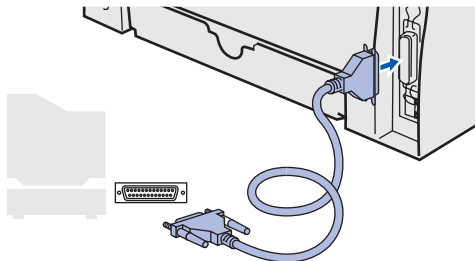

- 5 Read the license agreement carefully. Then follow the on-screen instructions.

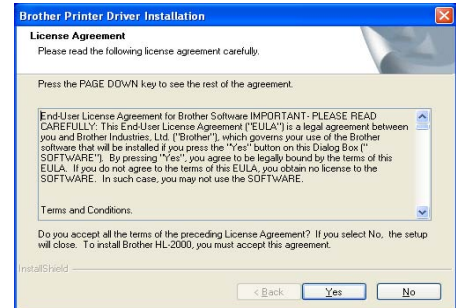

- 6 Click the **Finish** button.



*If you want to register your product on-line, check the **On-Line Registration** box.*

- 7 Turn on the printer power switch.



- OK! **The Setup is now complete.**

For Network Interface Cable Users (HL-2070N Users)

For Brother Peer-to-Peer Network Printer Users (LPR / NetBIOS)

- If you are going to connect the printer to your network, we recommend that you contact your system administrator prior to installation or see the Network User's Guide.
- Before installation, if you are using Personal Firewall software (e.g. the Internet Connection Firewall available in Windows XP), disable it. Once you are sure that you can print, re-start your Personal Firewall software.

Connecting the printer to your network and installing the driver

- 1 Click **Install Printer Driver** on the Menu screen.



- 2 Select the **Network** interface.



- 3 Turn off the printer power switch.



- 4 Connect the network interface cable to the printer, and then connect it to a free port on your hub.

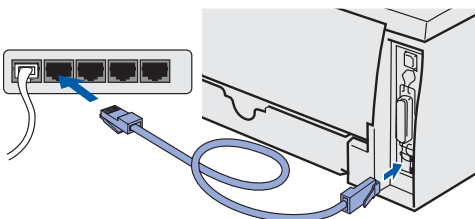

- 5 Turn on the printer power switch.



- 6 Read the license agreement carefully. Then follow the on-screen instructions.

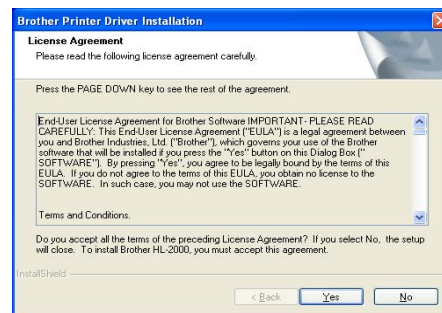

- 7 Select **Brother Peer-to-Peer Network Printer**, and then click the **Next** button.

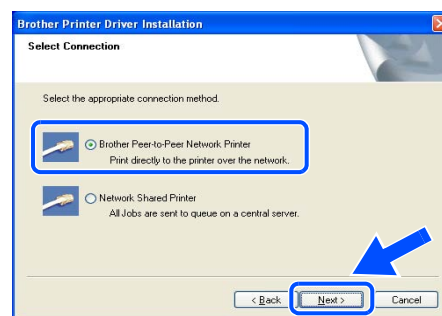

Continue to
the next page

For Network Interface Cable Users (HL-2070N Users)

- 8 For LPR Users:**
 Select **Search the network for devices and choose from a list of discovered devices (Recommended)**. Or enter your printer's IP address or its node name. Click the **Next** button.

For NetBIOS Users:
 Select **Search the network for devices and choose from a list of discovered devices (Recommended)**. Click the **Next** button.



 *Contact your administrator if you are not sure about the printer's IP address or Node name.*

- 9 For LPR Users:**
 Select your printer and **LPR (Recommended)**, and then click the **Next** button.

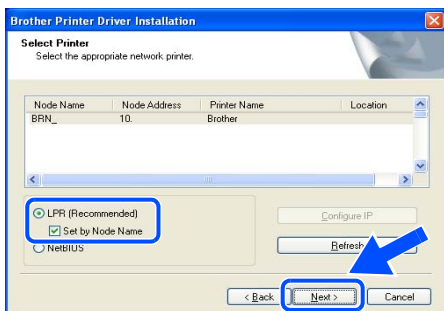

For NetBIOS Users:
 Select your printer and **NetBIOS**, and then click the **Next** button.

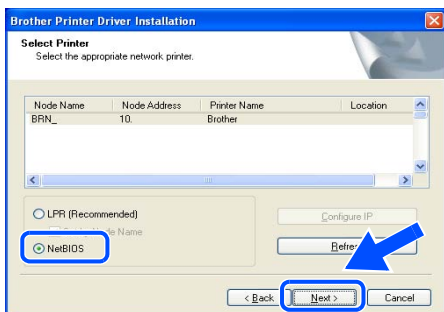

- 10** Click the **Finish** button.

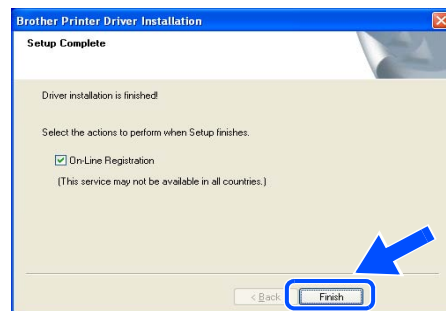

 *If you want to register your product on-line, check the **On-Line Registration** box.*

OK! For Windows NT® 4.0 and Windows® 2000/XP users:
 The Setup is now complete.

OK! For Windows® 95/98/Me users:
 After your PC has restarted, setup will be complete.

For Network Shared Printer Users



If you are going to connect to a shared printer on your network, we recommend that you ask your system administrator about the queue or share information of the printer prior to installation.

Installing the driver and selecting the appropriate printer queue or 'share name'

- 1 Click **Install Printer Driver** on the Menu screen.



- 2 Select the **Network** interface.



- 3 Read the license agreement carefully. Then follow the on-screen instructions.



- 4 Select **Network Shared Printer**, and then click the **Next** button.

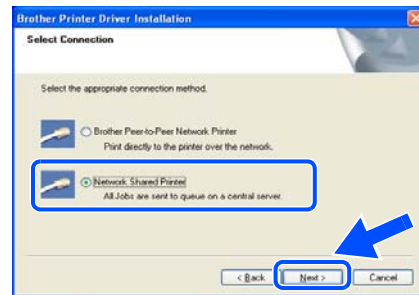

- 5 Select your printer's queue, and then click the **OK** button.

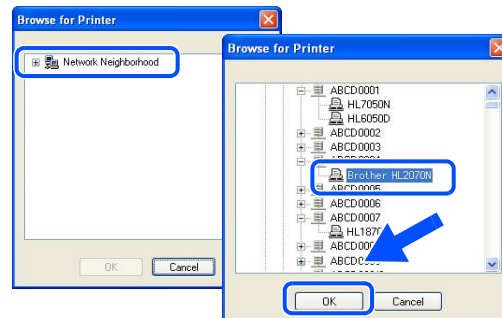

Contact your administrator if you are not sure about the location and name of the printer in the network.

- 6 Click the **Finish** button.

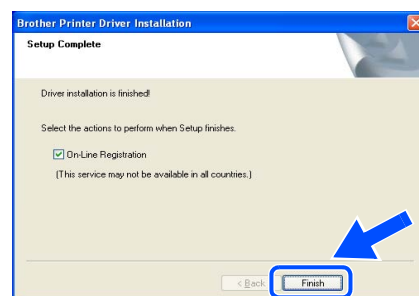

If you want to register your product on-line, check the **On-Line Registration** box.



The setup is now complete.



For USB Interface Cable Users

For Mac OS® X 10.2.4 or greater Users

Connecting the printer to your Macintosh & installing the driver

- 1 Click **Install Printer Driver** on the Menu screen.

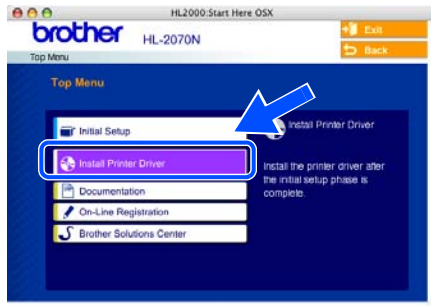

- 2 For HL-2030/2040 users:
Select the **USB interface**.



For HL-2070N users:
Select the **USB interface**.



- 3 Connect the USB interface cable to your Macintosh, and then connect it to the printer.



Do not connect the USB cable to the keyboard USB Port or a non-powered USB Hub.

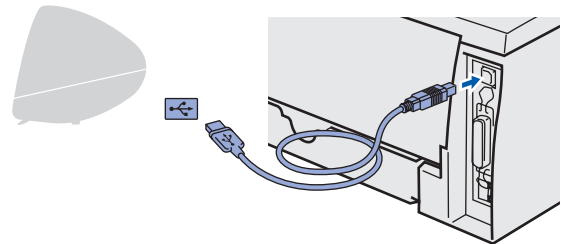

- 4 Make sure the printer power switch is on.



- 5 From the **Go** menu, select **Applications**.

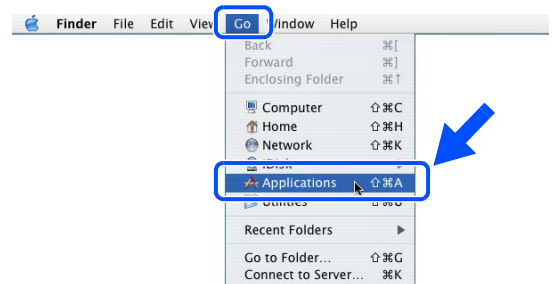

- 6 Open the **Utilities** folder.

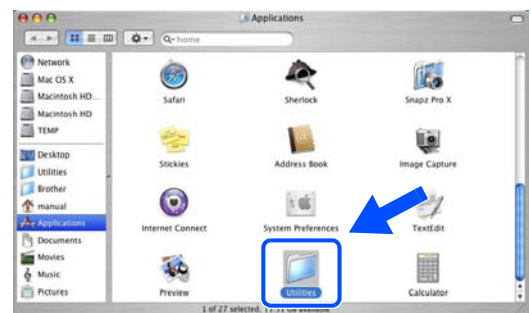

7 Open the **Printer Setup Utility** icon.

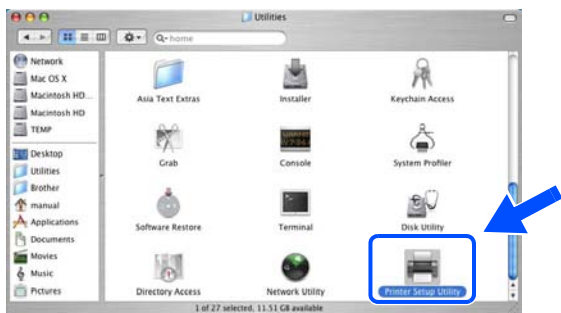

8 Click **Add**.

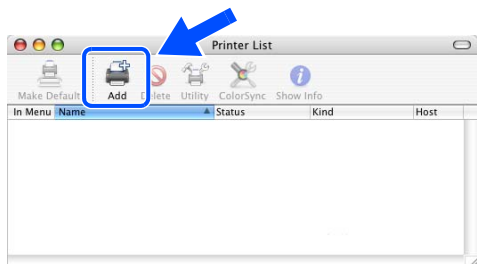

9 Select **USB**.

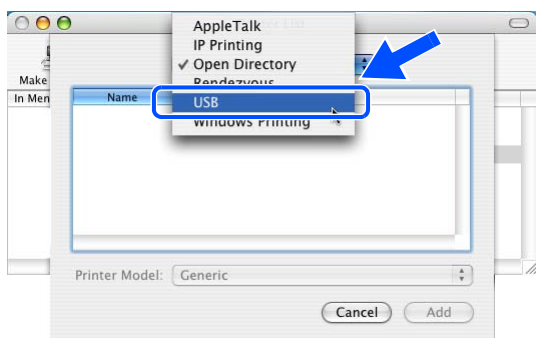

10 Select the appropriate printer, and then click the **Add** button.

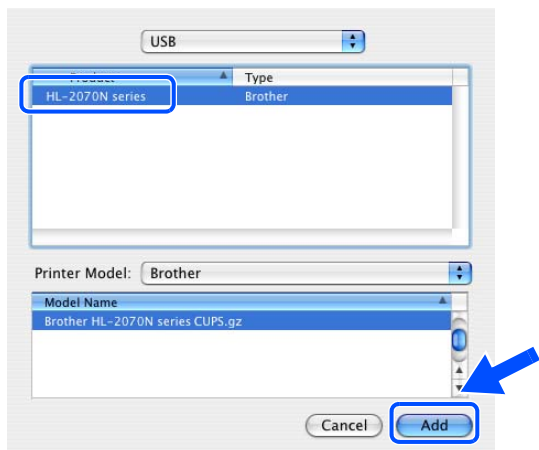

11 From the **Printer Setup Utility** menu, select **Quit Printer Setup Utility**.

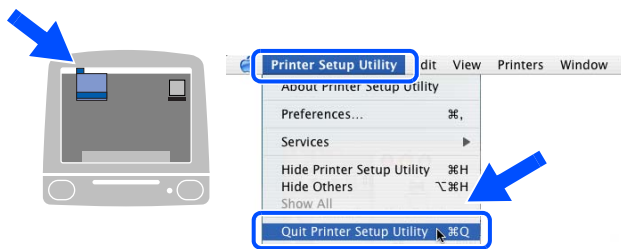

OK! The setup is now complete.



For USB Interface Cable Users

For Mac OS[®] 9.1 to 9.2 Users

Connecting the printer to your Macintosh & installing the driver

- 1 Insert the CD-ROM into your CD-ROM drive. Open the **Mac OS 9** folder.

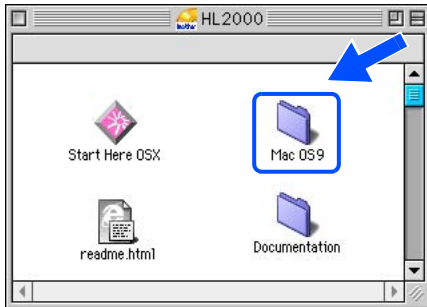

- 2 Open your language folder.



- 3 Double-click the **Printer Driver Installer** icon to install the printer driver. Follow the on-screen instructions and restart your Macintosh.

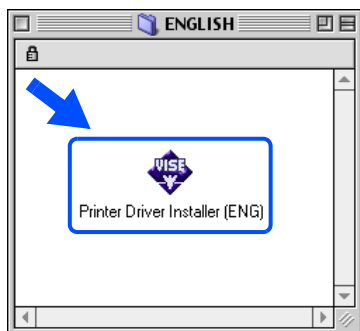

- 4 Connect the USB interface cable to your Macintosh, and then connect it to the printer.



Do not connect the USB cable to the keyboard USB Port or a non-powered USB Hub.

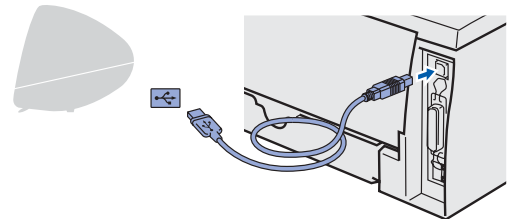

- 5 Make sure the printer power switch is on.



- 6 From the **Apple** menu, open the **Chooser**.

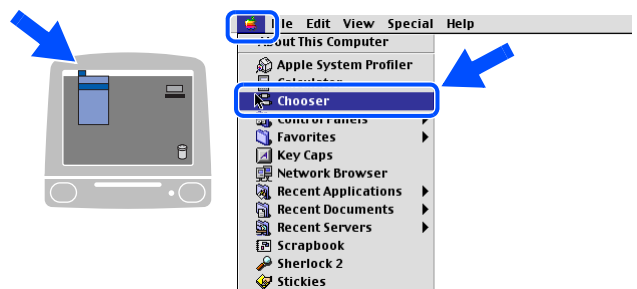

- 7 Click the **Brother Laser** and select the appropriate printer. Close the **Chooser**.

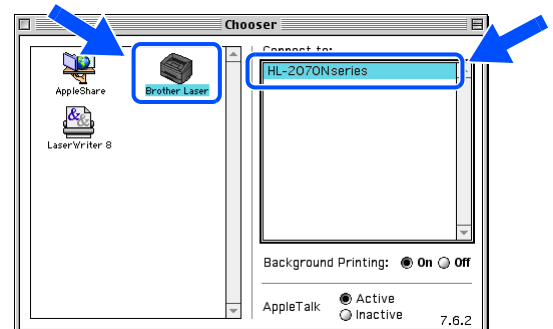

- OK! The setup is now complete.

For Network Interface Cable Users (HL-2070N Users)

For Mac OS® X 10.2.4 or greater Users

Connecting the printer to your Macintosh & installing the driver

- 1 Click **Install Printer Driver** on the Menu screen.



- 2 Select the **Network interface** and follow the on screen instructions.



- 3 Turn off the printer power switch.



- 4 Connect the network interface cable to the printer, and then connect it to a free port on your hub.

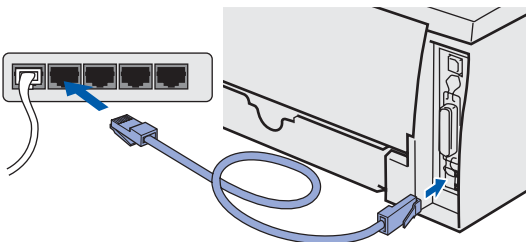

- 5 Turn on the printer power switch.



- 6 From the **Go** menu, select **Applications**.

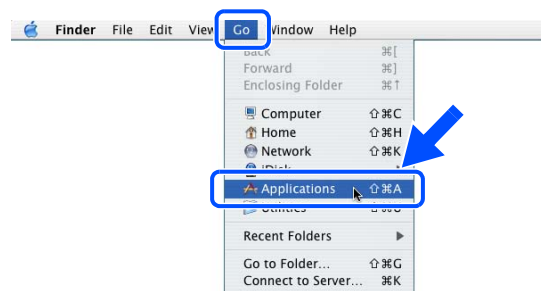

- 7 Open the **Utilities** folder.



Continue to
the next page

Step 2

Installing the Driver

For Network Interface Cable Users

8 Double-click the **Printer Setup Utility** icon.

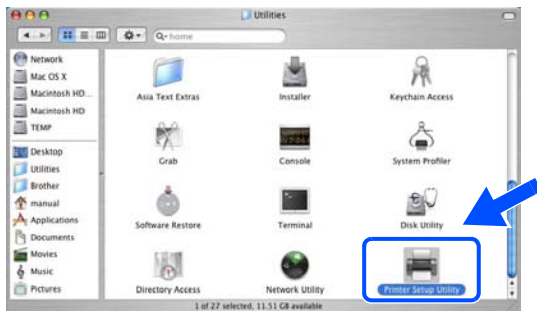

9 Click **Add**.

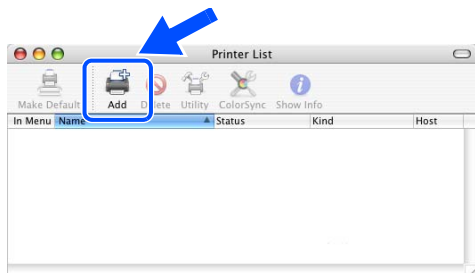

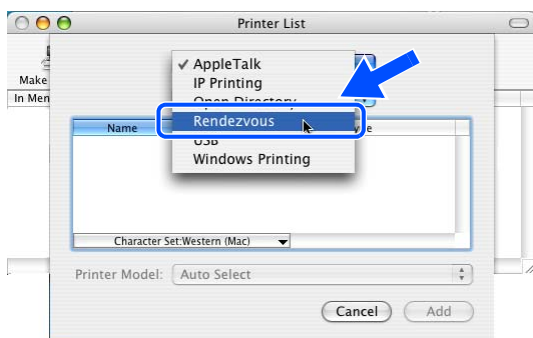

10 Make the following selection.

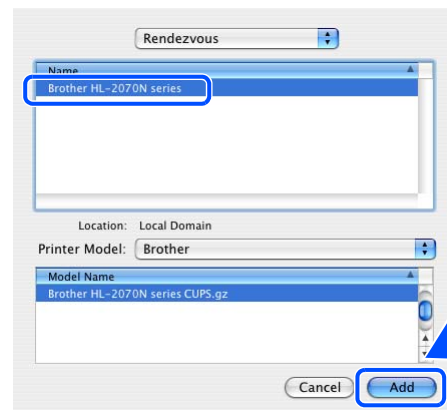

11 Select **Brother HL-2070N series**, and then click the **Add** button.



 If there is more than one of the same model printer (HL-2070N) connected on your network, the Ethernet address (MAC address) will be displayed after the model name.

 Network User's Guide Chapter 6.

12 From the **Printer Setup Utility** menu, select **Quit Printer Setup Utility**.

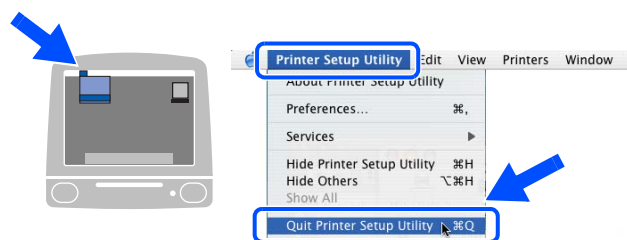

 **The setup is now complete.**

For Mac OS® 9.1 to 9.2 Users

Connecting the printer to your Macintosh & installing the driver

- 1 Turn off the printer power switch.



- 2 Connect the network interface cable to the printer, and then connect it to a free port on your hub.

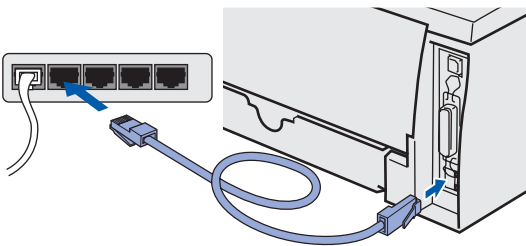

- 3 Turn on the printer power switch.



- 4 Insert the CD-ROM into your CD-ROM drive. Open the **Mac OS 9** folder.

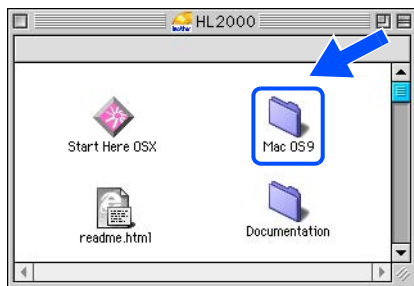

- 5 Open your language folder.

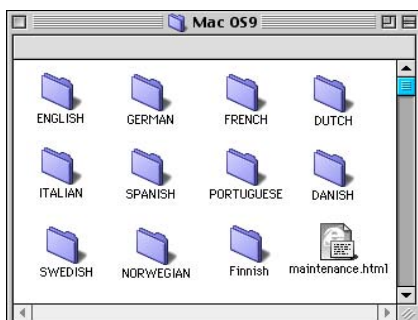

- 6 Double-click the **Printer Driver Installer** icon to install the printer driver. Follow the on-screen instructions.



- 7 From the **Apple** menu, Open the **Chooser**.



- 8 Click the **Brother Laser (IP)** icon, and then select **BRN_XXXXXX***. Click the **Setup...** button.

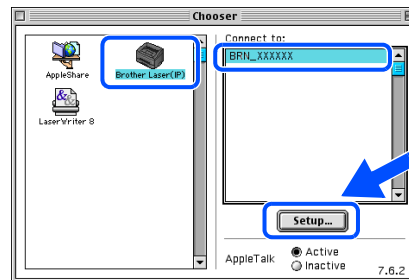

* Where xxxxxx are the last six digits of the Ethernet address.

Network User's Guide Chapter 6.



- 9 Click the **OK** button. Close the **Chooser**.

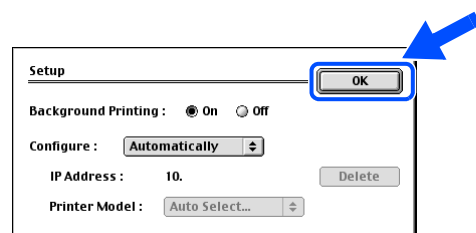

- OK!** The setup is now complete.

■ For Administrators (HL-2070N Users)

Installing the BRAdmin Professional Configuration Utility (Windows® Users Only)

The BRAdmin Professional utility is designed to manage your Brother network connected devices. For more information on BRAdmin Professional go to <http://solutions.brother.com>

- 1 Insert the CD-ROM into your CD-ROM drive. The opening screen will appear automatically. Follow the on-screen instructions.

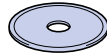

- 2 Click the **Install Other Drivers or Utilities** icon on the menu screen.



- 3 Click **BRAdmin Professional**. Follow the instructions on the screen.

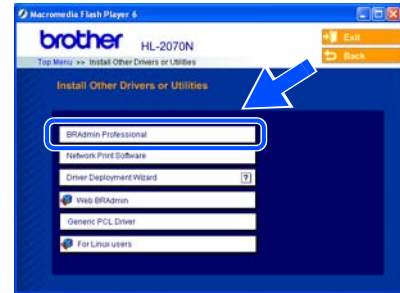

The default password for the print server is 'access'. You can use the BRAdmin Professional software to change this password.

Setting your IP Address, Subnet Mask and Gateway using BRAdmin Professional (Windows® Users Only)



If you have a DHCP/BOOTP/RARP server in your network, you don't have to do the following operation. Because the print server will automatically obtain its IP address.

- 1 Start BRAdmin Professional, and select **TCP/IP**.

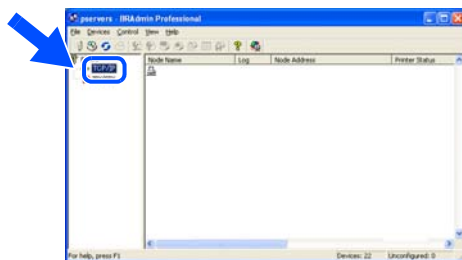

- 2 Select **Search Active Devices** from the **Devices** menu. BRAdmin will search for new devices automatically.

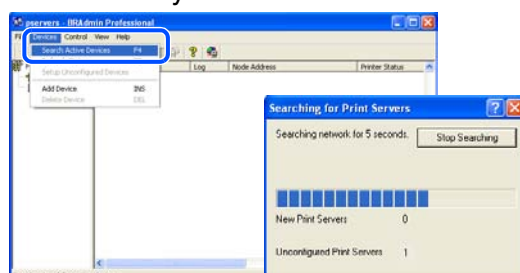

- 3 Double-click the new device.

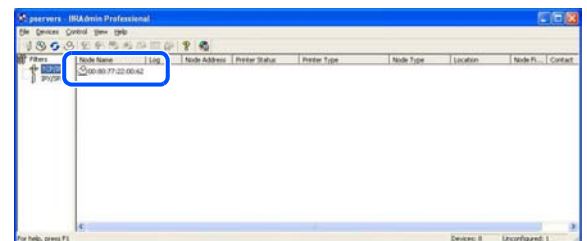

- 4 Enter the **IP Address, Subnet Mask and Gateway**, and then click the **OK** button.

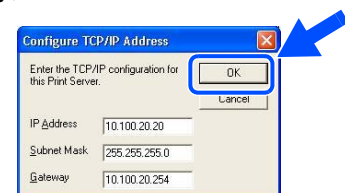

- 5 The address information will be saved to the printer.

Web browser

The Brother print server is equipped with a web server that allows you to monitor its status or change some of its configuration settings, using HTTP (Hyper Text Transfer Protocol).



The User Name is '**admin**' and the default Password is '**access**'. You can use the web browser to change this password.



Network User's Guide Chapter 2.

Network Factory Default Setting

If you wish to reset the print server back to its default factory settings (including password), please follow these steps:

- 1 Turn off the printer.
- 2 Make sure that the front cover is closed and the power cord is plugged in.
- 3 Hold down the **Go** button as you turn on the power switch. Keep the **Go** button pressed down until the **Toner**, **Drum** and **Paper** LEDs light up. Release the **Go** button. Make sure that the **Toner**, **Drum** and **Paper** LEDs are off.
- 4 Press the **Go** button six times. Make sure that all the LEDs light up when the print server has been reset to its default factory settings.

Print the Printer Settings Page

The Printer Settings Page lists all the current printer settings, including network settings. To print the Printer Settings Page, press the **Go** button three times.

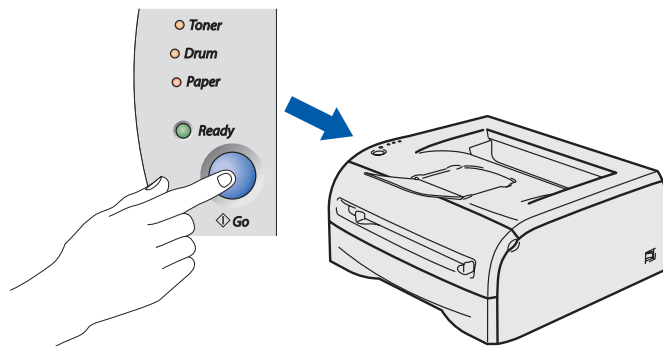

Shipment of the Printer

If for any reason you must ship your Printer, carefully package the Printer to avoid any damage during transit. We recommend that you save and use the original packaging. The Printer should also be adequately insured with the carrier.



When shipping the printer, the DRUM UNIT assembly and TONER CARTRIDGE must be removed from the printer and placed in a plastic bag. Failure to remove the unit and place it in a plastic bag before shipping will cause severe damage to the printer and may VOID THE WARRANTY.

- 1 Turn off the printer power switch, and then unplug the AC power cord.

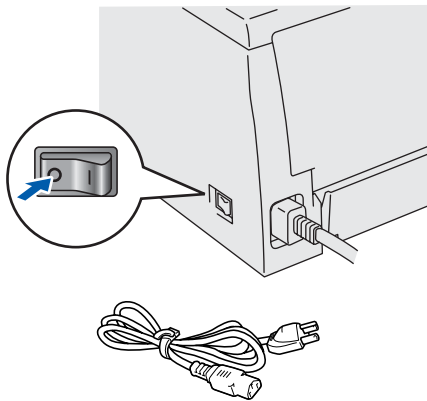

- 2 Remove the drum unit assembly. Place it in a plastic bag and seal the bag completely.

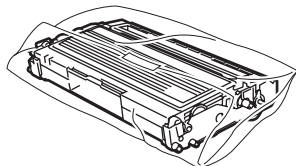

- 3 Re-pack the printer.

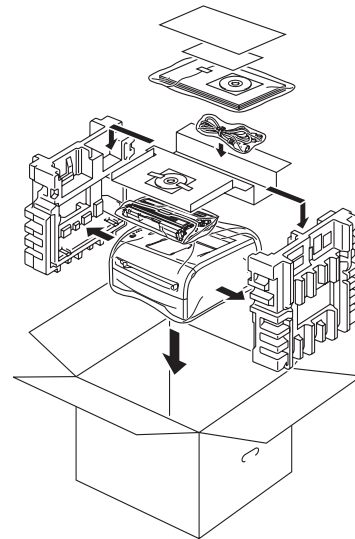

Trademarks

The Brother logo is a registered trademark of Brother Industries, Ltd.

Windows and Windows NT are registered trademarks of Microsoft Corporation in the U.S and other countries.

Apple, Macintosh and Mac OS are registered trademarks of Apple Computer, Inc.

ENERGY STAR is a U.S. registered mark.

All other brand and product names mentioned in this Quick Setup Guide are registered.

Compilation and Publication

This manual has been compiled and published, under the supervision of Brother Industries Ltd., covering the latest product descriptions and specifications.

The contents of this manual and the specifications of this product are subject to change without notice.

Brother reserves the right to make changes without notice in the specifications and materials contained herein and shall not be responsible for any damages (including consequential) caused by reliance on the materials presented, including but not limited to typographical and other errors relating to the publication.

This product is designed for use in a professional environment.

Option

The printer has the following optional accessories. You can expand the capability of the printer by adding these items.

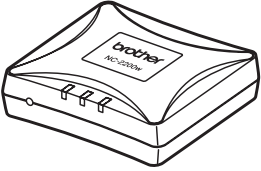
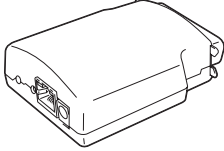

User's Guide Chapter 4.

| Wireless (IEEE802.11b) Print Server | External Print Server |
|---|---|
| NC-2200w | NC-2100p (For HL-2040 only) |
|  <p>If you are going to connect the printer to your wireless network, purchase the optional Wireless print server. The NC-2200w can be connected to the USB interface port of your printer. For more information, visit http://solutions.brother.com.</p> |  <p>If you are going to connect the printer to your network, buy the optional Network device. The NC-2100p can be connected to the parallel interface port of your printer. For more information, visit http://solutions.brother.com.</p> |

Consumables

When the time comes to replace consumables, an error will be indicated by the LED's on the Control Panel.

For more information about the consumables for your printer, visit <http://solutions.brother.com> or contact your local Brother re-seller.

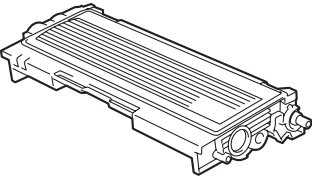
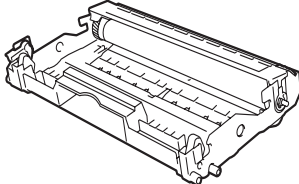

User's Guide Chapter 5.

| Toner Cartridge | Drum Unit |
|---|---|
|  |  |

brother®